

To jest moja klasa.

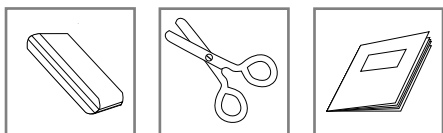

Hier hast du ein Quartett zum Sammeln. Du fragst deine Spielpartner nach Farben, Zahlen oder Gegenständen und sammelst vier Karten zum gleichen Thema, die du ablegen darfst. Wer zuerst keine Karten mehr hat, hat gewonnen.

To jest moja szkoła.



ołówek

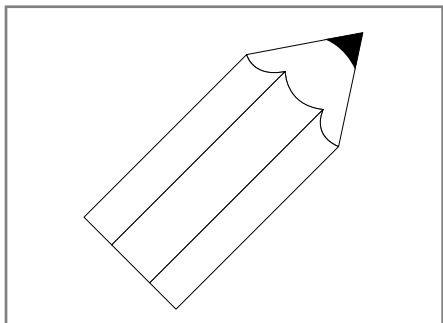

To jest moja szkoła.

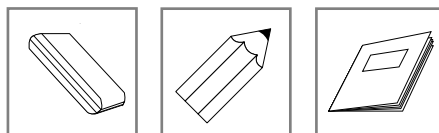

nożyczki

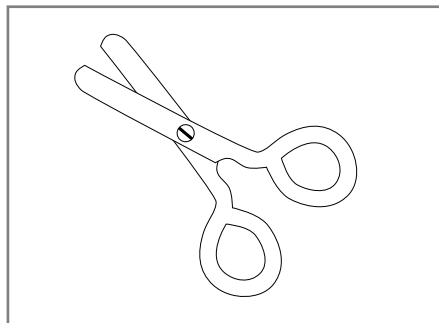

To jest moja szkoła.

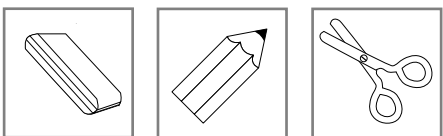

zeszyt

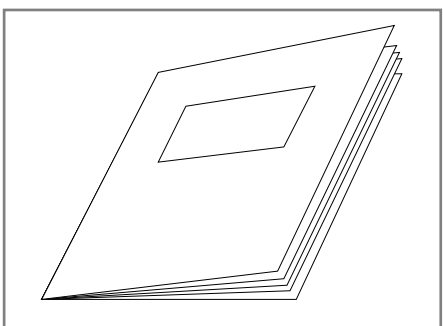

To jest moja szkoła.

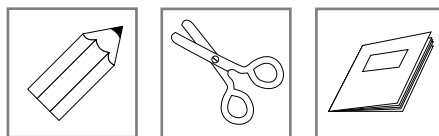

gumka

